

# IKI

KIUKAISTA KIUKAIN

## Instruction manual



## IKI | PRO

IKI Pro 14  
IKI Pro 21  
IKI Pro 28  
IKI Pro 35

4/2019

This instruction manual is intended for the owner or the person responsible for the upkeep of the sauna as well as for the electrician in charge of installation. Once installation is completed, the instruction manual must be handed over to the owner or manager. The purpose of the heater is to heat a sauna room to a temperature appropriate for sauna-bathing; any other use is prohibited.

### **Please note the following before beginning installation:**

- Beware of sharp edges in the heater frame. Wear a long-sleeved shirt and protective gloves during installation and laying of the stones.
- Before installation read through the instructions for installation and use.
- The warranty does not cover malfunctions caused by faulty installation or use.

## **CONTACT DETAILS**

**Technical support**  
(Mon-Fri 9-16)  
+ 358 600 550 133  
(1,49 €/min + Inc)  
tuki@ikikiuas.fi

**IKI Kiuas Plc**  
Hakaniemenkatu 11  
00530 Helsinki  
ikikiuas@ikikiuas.fi

**Vallila pick up storage**  
Pälkäneentie 5  
00510 Helsinki  
vallila@ikikiuas.fi

**Production site /  
Pieksämäki**  
Niilontie 10  
76150 Pieksämäki  
tuotanto@ikikiuas.fi

## Contents

Instructions for installation and laying of the stones .....	3
Connecting the heater to electricity.....	5
Circuit diagram .....	6
Physical installation instructions for Pro-B2 control unit.....	7
Heater measurements.....	9
Heater safety distances .....	9
Troubleshooting .....	10
Quality requirements for water .....	10
Instructions for use.....	10
Warranty.....	11
Quality guarantee / Freight guarantee.....	11
Ventilation .....	13
Illustration of ventilation .....	13
Warnings.....	14

## Instructions for installation and laying of the stones

1. Check that all the required items are included in the delivery. The heater has four parts: heater base with the heating elements, a guide that fits around the heating elements, as well as an inner and an outer frame.
2. Select the location for the heater to be installed in following the proper safety distances (**page 7**). Make sure that water will not puddle under the heater, where it may vaporise and corrode the connections and wiring inside the heater.
3. Take into consideration the location of the air vents, the thermostat (**page 5**) and control unit (Ref. the separate installation instructions for the control unit).
4. Lift off the outer frame to reveal the inner frame (**installation image 1**).
5. Lift the inner frame that surrounds the heating elements off the heater base (**installation image 2**).
6. Open the base plate under the heater (**installation image 3**).
7. Perform the electrical connections according to the circuit diagram on **page 6**.
8. Connect the wiring to the central unit according to the instructions found in the central unit.
9. Test that the heating elements are functioning properly by switching the power on. If all the heating elements are working, close the base plate. If one or more of the heating elements fail to heat up, or there is another problem, such as a fuse blowing, contact the manufacturer.
10. **LAYING THE STONES:** We recommend using small Kerkes Tetra ceramic interspace sauna stones around the heating elements. The specially designed Kerkes stones support and protect the heating elements, and they do not disintegrate prematurely. As surface stones, we recommend using large Kerkes Tetra or rough-cut olivine, olivine diabase or peridotite (e.g. Parhaat Lölylyt) stones the size of 5 to 10 cm in diameter. The warranty period is extended when using Kerkes stones (ref. p. 9 for warranty specifications). **NOTE!** Soapstone, rounded stones or natural stones may only be used at the surface level. See **page 4** for specified stone-laying instructions.
11. IKI Kiuas recommends, for safety reasons, building a safety railing around the heater, when the heater is used in a public sauna. Make sure to follow the appropriate safety distances for the railing.
12. As the stones settle down, during use, the surface drops down a little. Add more stones, if needed. The frequency with which the stones should be replaced depends on stone quality and frequency of sauna use. Check the condition of the stones yearly, remove any broken ones and replace them with new ones.

### STONE ALTERNATIVES AND RECOMMENDATIONS FOR INSTITUTIONAL OR PROFESSIONAL USE:

#### Option 1.

- Professional use: public baths, health clubs, etc. where the heater is active 12-18 hours a day (Ref. p. 9 for warranty specifications)

Maximum need:	IKI Pro 14 and 21	IKI Pro 28	IKI Pro 35
Kerkes, tetra small	120 kg	140 kg	180 kg
Kerkes, tetra large	120 kg	160 kg	180 kg

#### Option 2.

- Semi-professional use (e.g. shared & communal saunas in buildings and private functions) where the heater is functional no more than 8-10 hours a day (Ref. p. 9 for warranty specifications)

Maximum need:	IKI Pro 14 and 21	IKI Pro 28	IKI Pro 35
Kerkes, tetra small (interspace)	40 kg	60 kg	80 kg
Regular sauna stone (smaller than 10 cm)	200 kg	240 kg	280 kg

## Installation and stone-laying instructions

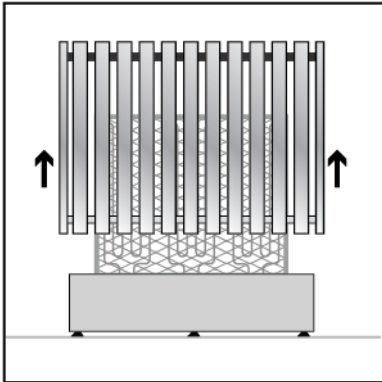

Image 1

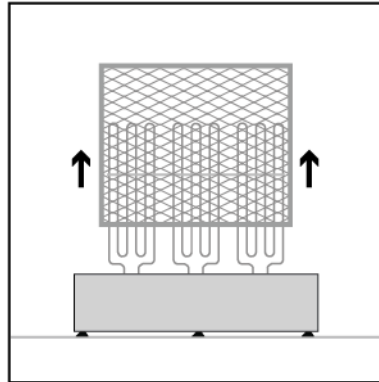

Image 2

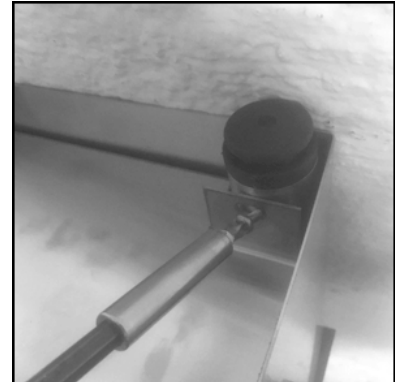
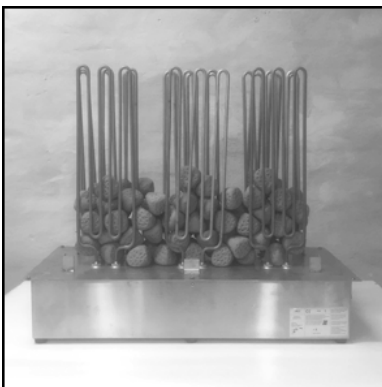
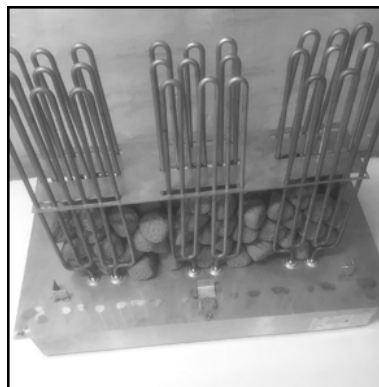

Image 3



1. Lift and remove the heating element guide and place small Kerkes tetra stones in between the elements one by one.



2. Put the guide back when the stones have filled the lower half of the heater.



3. Place about 6 small Kerkes tetra stones on the top and in between the heating elements to keep them separated.

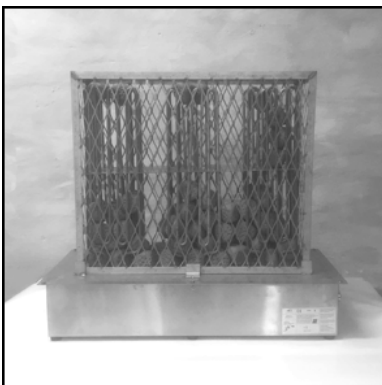

4. Place the inner frame around the heating elements. Make sure it rests firmly on the base plate.

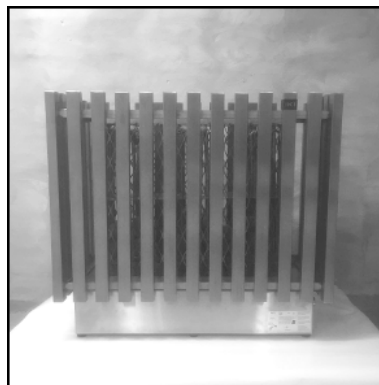

5. Put the outer frame on.



6. Finally, lay large Kerkes tetra stones between the inner and outer frame. Place large and small stones on top of the inner frame.

**NOTE!** If you use rough-cut olivine, or other, stones instead of Kerkes stones, (alternative 2 – semi-professional use.), the diameter of the stones should be between 5 and 10 cm. Follow the same instructions as above to fill the space between the inner and outer frames.

## Connecting the heater to electricity

The heater is connected to the electric supply with a H07RN-F, or similar, rubber cable. The use of PVC-insulated cables is forbidden due to poor heat resistance. **The electrical installation must be performed by a licenced electrician and must adhere to current legislation.** The connecting cable must be installed safely away from mechanical strain and heat radiation. If the rubber cable runs inside wall panelling 1000 mm above the floor, it needs to be heat resistant up to 170 degrees Celsius (e.g. SSJ).

## Control unit

For installation, refer to the separate installation instructions specific to the control unit.

## Sauna's temperature sensor and overheating protector

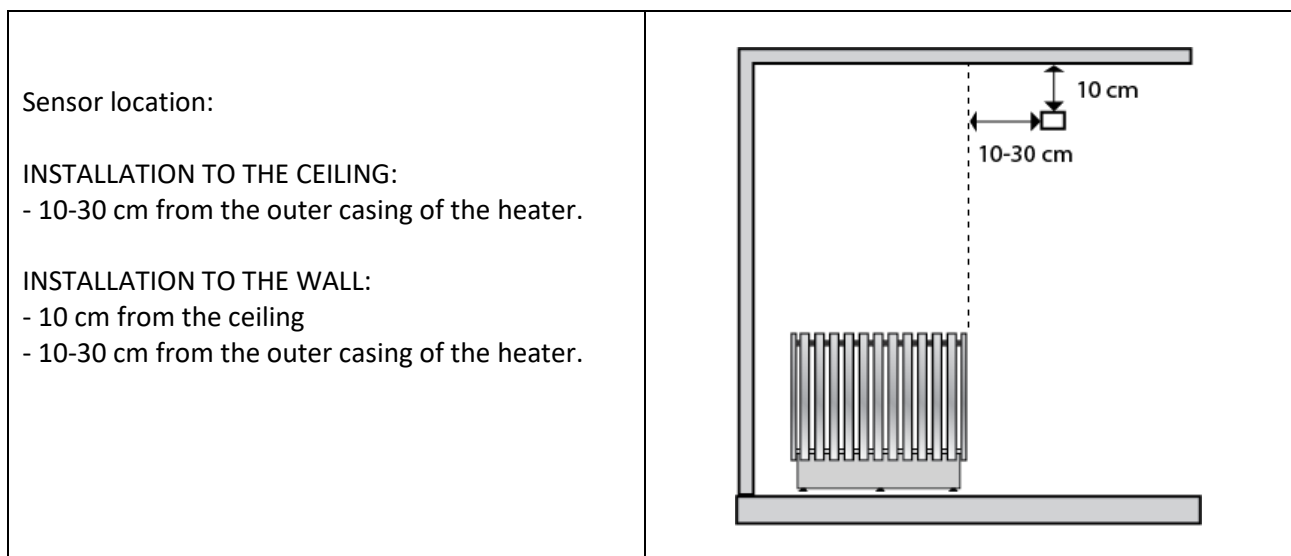

### NOTE!

Make sure the temperature sensor is not located less than 1000 mm distance from an undirected air inlet vent, or less than 500 mm from a vent that is directing air away from the sensor.

Temperature limiter will switch off the power from the heater, if the temperature in the sauna raises dangerously high (139) due to a malfunction.

## Circuit diagram

### Electrical one-way switch connection for Pro14

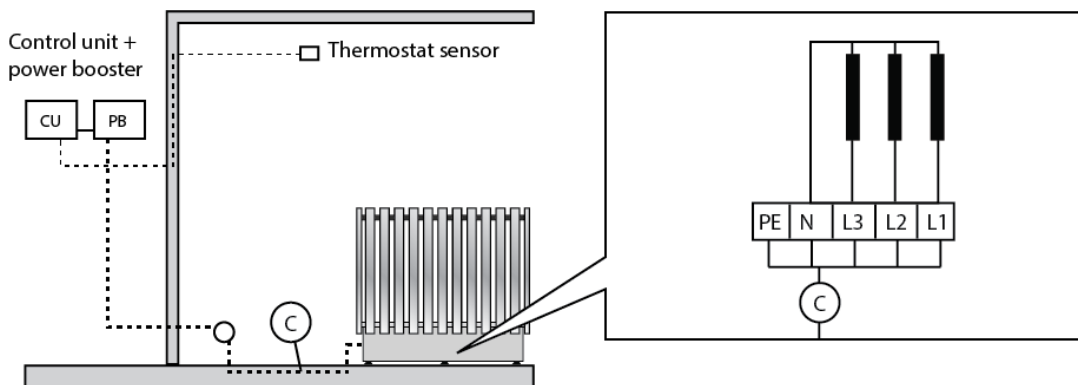

### Electrical two-way switch connection for Pro 14, 21 and 28

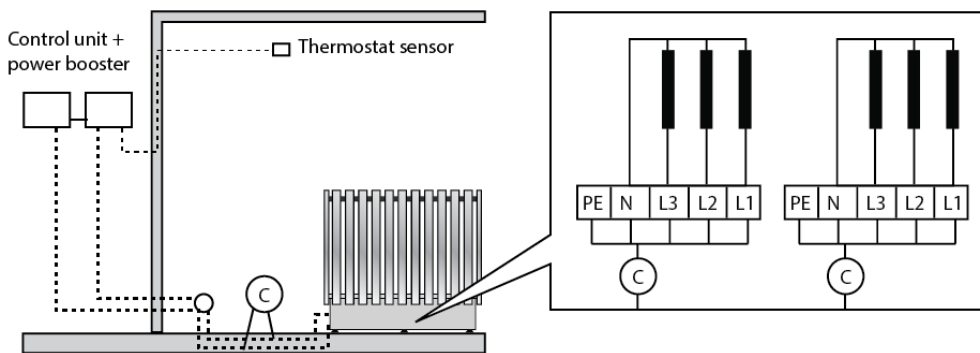

### Electrical three-way switch connection for Pro 35

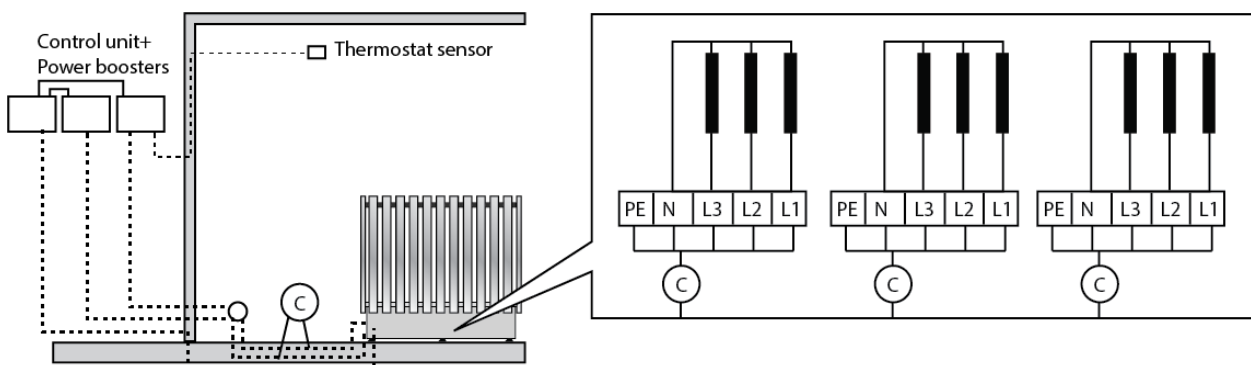

If the control unit (e.g. Pro-B2 or Wave) requires an additional contactor, we recommend a two- or three-way switch connection to distribute the power evenly to the control unit and the additional contactor.

# Physical installation instructions for Pro-B2 control unit

Physical instructions / IKI Pro 14 | 13,8 kW | 2-way switch connection  
 Pro-BP control unit + S2-30 additional contactor unit

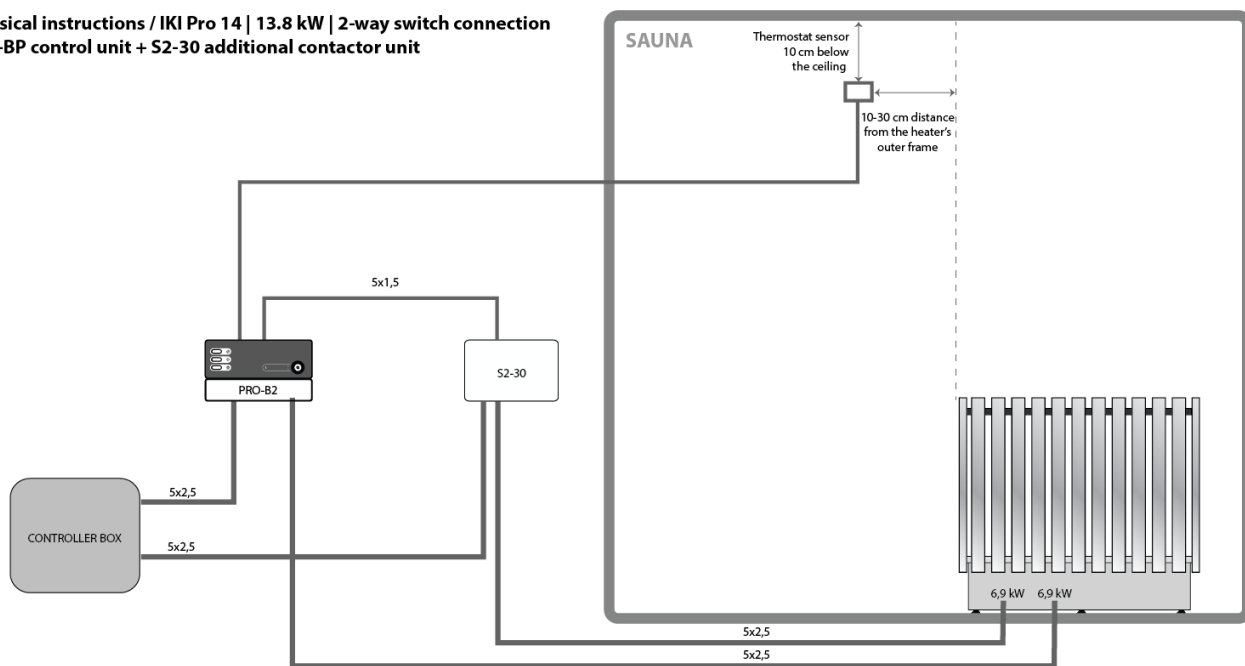

Physical instructions / IKI Pro 21 | 20,7 kW | 2-way switch connection  
 Pro-BP control unit + S2-30 additional contactor unit

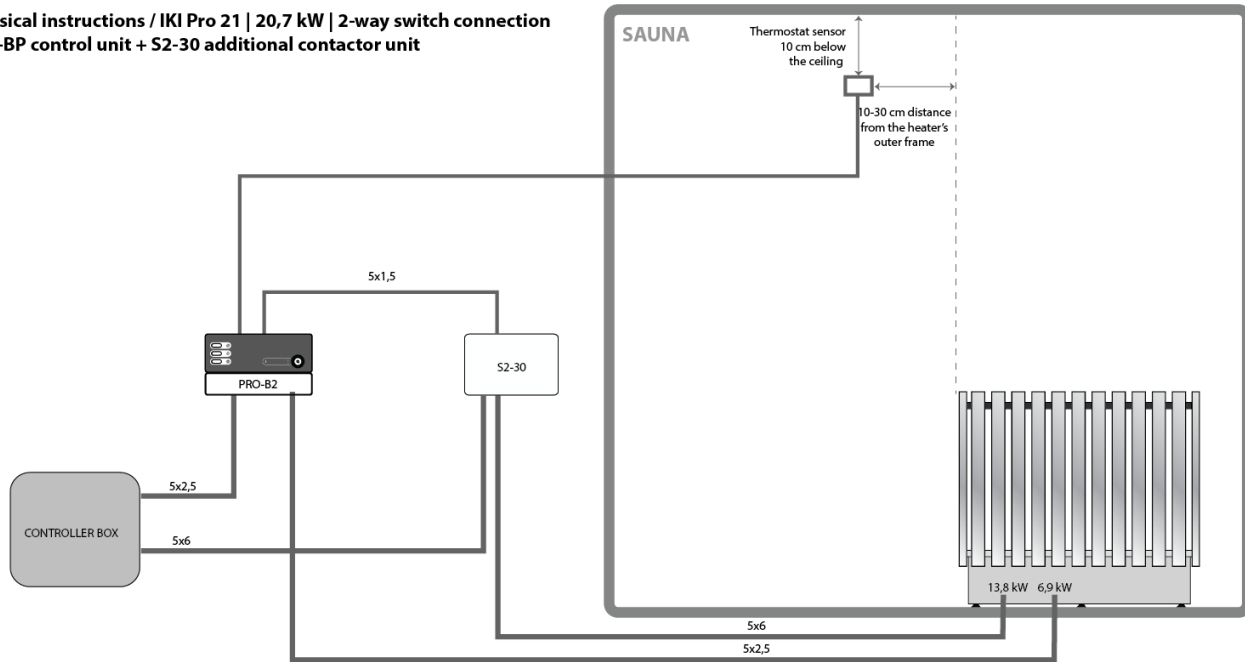



**Physical instructions / IKI Pro 28 | 27.6 kW | 2-way switch connection  
Pro-BP control unit + S2-30 additional contacto units**

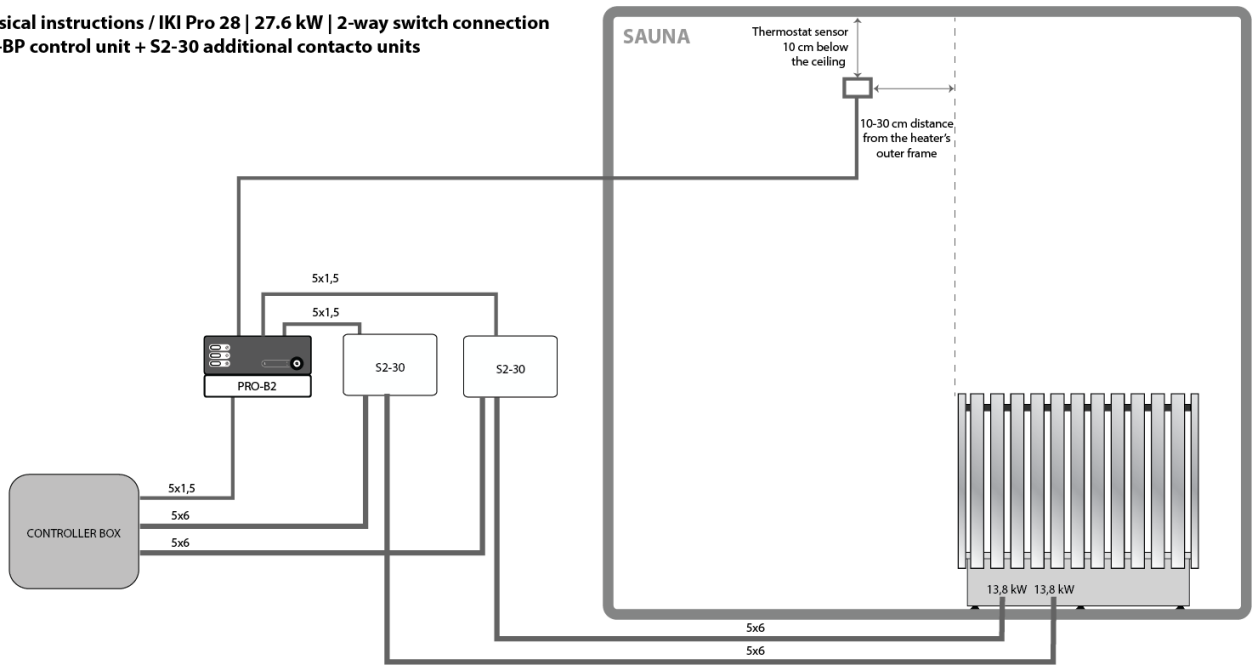

**Physical instructions / IKI Pro 35 | 34.5 kW | 3-way switch connection  
Pro-BP control unit + 2 x S2-30 additional contactor unit**

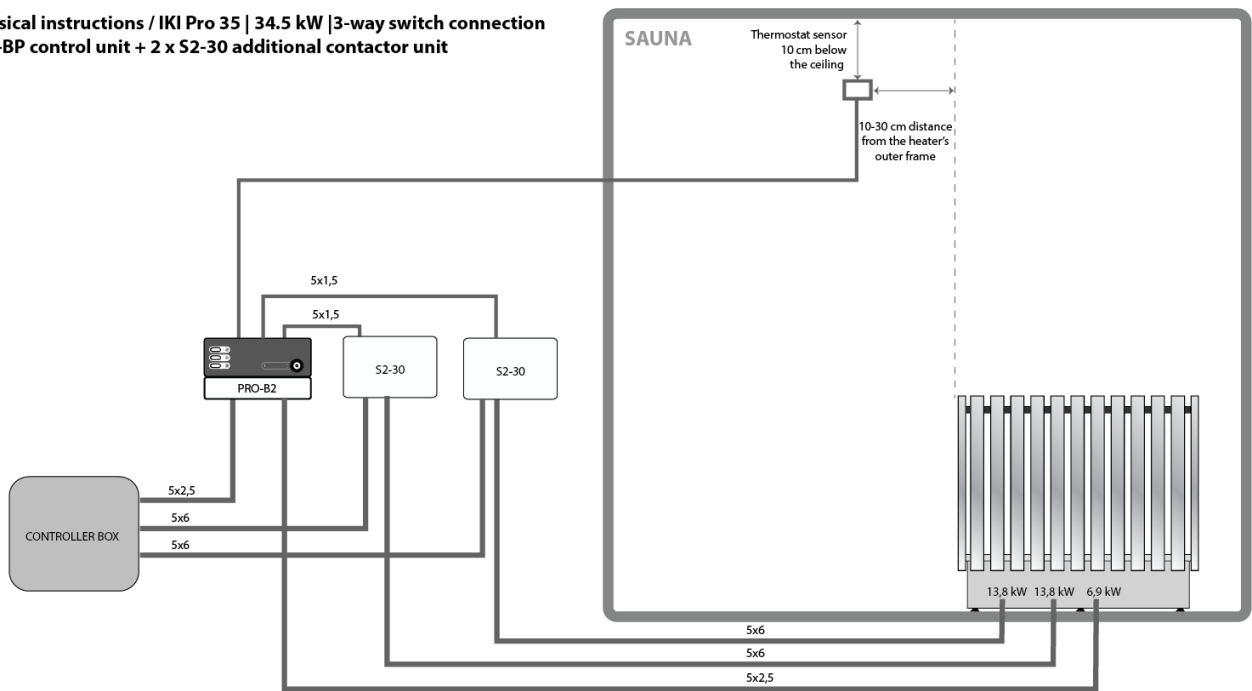

## Heater measurements

Heater model	Sauna room size	Heater height	Heater width / depth	Maximum stone capacity	Heater power
IKI Pro 14	15-25 m <sup>3</sup>	79 cm	88 / 44 cm	240 kg	13,8 kW
IKI Pro 21	20-35 m <sup>3</sup>	79 cm	88 / 44 cm	240 kg	20,7 kW
IKI Pro 28	26-42 m <sup>3</sup>	79 cm	88 / 51 cm	300 kg	27,6 kW
IKI Pro 35	35-50 m <sup>3</sup>	79 cm	88 / 58 cm	360 kg	34,5 kW

## Heater safety distances

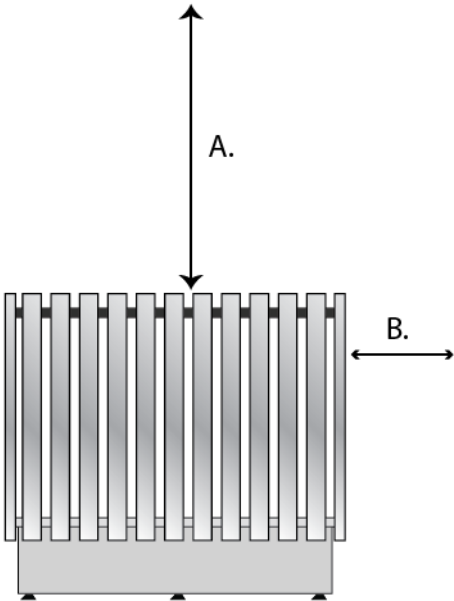

Safety distance to inflammable materials (e.g. wooden wall panelling or benches):

- A. 1200 mm upwards measured from the top of the heater
  
- B. 150 mm\*) mm to the sides, back and front, measured from the outer casing

\*) The safety distance to inflammable materials can be reduced by half by installing for example a stainless-steel fire protection plate (with a 3 cm air gap).

## Troubleshooting

If the heater fails to heat up, check that

- Electricity has been wired properly
- Fuses are intact
- Timer switch is set for heating
- The thermostat is set to a higher temperature than current room temperature
- The overheating protector has not gone off. If it has, the reason must be resolved before attempting to re-heat the heater.
- The stones are laid correctly.

If you find discoloration in the wooden structures near the heater, check that the safety distances are followed correctly, that the stones have been laid correctly and the heating elements are not exposed or touching one another. The heat radiation from exposed elements is extreme and can cause discoloration.

## Quality requirements for water

Water properties	Effects	Recommendations
Humus concentration	Colour, taste, precipitates	<12 mg/l
Iron concentration	Colour, odour, taste, precipitates	<0,2 mg/l
Hardness: most important substances are manganese (Mn) and lime, i.e. calcium (Ca)	Precipitates	Mn: <0,05 mg/l Ca: <100 mg/l
Chlorinated water	Health risk	Forbidden
Sea water	Accelerated corrosion	Forbidden

## Instructions for use

- Before bathing for the first time, heat up the heater once to burn off protective oil solvents. Air out the sauna room efficiently afterwards.
- The heating time is about 45–75 minutes depending on the size of the room and its ventilation. Recommended bathing temperature with IKI heaters is 50–70 degrees. Pouring water on the stones increases the temperature and humidity.
- In continuous use, set the desired heating temperature from the control unit.
- Check that the heating elements do not become exposed as the stones shift about due to heat expansion.
- Check the condition of the stones once a year, and clean and replace as necessary.

Do not throw water onto the heater when there are people close-by: the steam is burning hot. Do not throw too much water on to the heater in one go. Maximum amount is half a litre at a time.

## Warranty

IKI Kiuas Ltd (the manufacturer) assures a warranty to its products as stipulated here, guaranteeing the quality and functionality of the products during the warranty period. The warranty applies to heaters sold and used in Finland. The warranty requires that the buyer follow the instructions regarding the placement of the heater, its installation, use and maintenance as well as those regarding the qualities of the stones used in the heater. The warranty period for IKI Pro electric heaters is 10 years for the structural parts (stainless steel frame) if installed according to the instructions and cared properly.

### TERMS OF WARRANTY FOR THE RESISTORS IN PROFESSIONAL USE:

#### **STONE ALTERNATIVE 1 (Kerkes stones, ref. p. 3)**

Factory-fitted resistors have a two (2) year warranty from the date of purchase.

Replacement resistors have a one (1) year warranty period from the date of purchase.

#### **STONE ALTERNATIVE 2. (other than Kerkes stones, ref. p. 3)**

Factory-fitted resistors have a six (6) month warranty from the date of purchase.

Replacement resistors have a one (1) month warranty period from the date of purchase.

The validity of the warranty for the resistors stipulates that the stones are installed in accordance with the instructions and that the heater is serviced at least every six months.

Service must include the following measures:

- Inspection and replacement of stones (if the stones are broken/ split)
- Checking and replacing the wiring (if oxidation occurs at the ends of resistor terminals or if the wiring has become frail)
- Possible tightening of resistors and check / replacement of seals

### IN CONSUMER USE:

Warranty of 2 years in ordinary use with both stone alternatives.

## Quality guarantee / Freight guarantee

The manufacturer guarantees the durability of the stainless-steel parts (resistor platform and frames) for 10 years. During the warranty period any defects that appear in the heater's raw materials or are production-based will be repaired free of charge. For example, the use of seawater on the heater is forbidden. Read through the requirements for water quality on page 10. The warranty does not cover colour changes, slipping or hair-line fractures, characteristic to natural stones, which do not affect the use or the safety of the heater.

**Damages occurred while shipping must to be recorded in the waybill when the product is received or within 7 days of delivery.** Shipping damage must also always be reported to the shipping company's last contact. The damaged part needs to be stored for inspection. Insurance compensates for the new part, which will be delivered by a public transporter. In all issues concerning warranty contact the store the product was bought from.

You may only use tap water for the heater, and the heater or its surroundings may be washed with pressure washer or hose.

1. In case of a defect or malfunction, the buyer must always contact the manufacturer or sales agent before searching for the cause or attempting to repair it. Any repairs must be agreed upon in writing with the manufacturer.
2. In private apartment use, the heater's stone space needs to be cleaned and stones re-piled at least once a year and weathered stones need to be replaced with new ones.
3. In institutional or professional use, the heater's stones must be re-piled at least three times a year during the warranty period. If this is not done, the warranty ceases to apply. In addition, the stones must be changed to new ones at least once a year. Proof, such as the product's purchase receipt, must be presented at request. The use of ceramic heater stones (other than those from Kerkes) is prohibited.
4. The warranty does not cover dismantlement or reinstallation on sauna benches, removal of sauna stones nor re-piling them. IKI Kiuas recommends using for the lower levels sauna benches that can be moved without using tools to dismantle structures.
5. The warranty for replacement parts is 12 months from the day of purchase. The replacement for the damaged part will be delivered to the sales agent free of cost. The installation of the replacement part must be carried out by a mechanic approved by the manufacturer. The manufacturer is not liable to reimburse any costs due to the removal of the faulty part or the installation of the replacement. The faulty part must be returned to the manufacturer at request and at their expense. The manufacturer will issue its freight contacts number for the delivery of the faulty part. Receipt from the reseller or certificate from a manufacturer's authorized mechanic will function as a warranty certificate.
6. **Warranty based on the conditions set by The Electrical Contractors' Association of Finland STUL.** STUL-warranty applies to electric heaters and control units if agreed upon in writing. In such cases, the conditions STUL has set are attached to these warranty conditions. When the use of STUL warranty has been agreed upon, they supersede these warranty regulations, if contradictory. For details, visit: <http://www.stul.fi/fi/in-english>
7. Limitations to warranty: The product owner must take good care of the product. On receiving the product, the owner is expected to check that it does not show signs of damage caused during shipping or storage. In case of such damage, they must contact the sales agent or transport company immediately. The manufacturer is not liable for any damages caused during shipping, or by inappropriate storage, installation or use against manufacturer's instructions, neglect of maintenance, or damage caused by placement of the heater in a place which does not meet the recommendations made by the manufacturer.
8. Damage notifications: The owner is responsible for notifying the manufacturer, the sales agent, or manufacturer's authorized mechanic of any damage or malfunction as soon as it appears and within 14 days. Any warranty related claims must be submitted within 14 days from the closing date of the product's warranty period.
9. Manufacturer's actions regarding warranty, continuation of warranty: In receipt of a substantiated warranty claim, the manufacturer will repair or change the product. This is done in the manufacturer's expense, and the manufacturer is free to select the most cost-effective alternative. The warranty for replacement parts is outlined above. The replacement part is granted warranty according to specifications. The warranty for a repaired part continues as before.

The manufacturer is not liable for reimbursing any expenses, business loss or other direct or indirect harm occurred to the buyer from damages or malfunction.

## Ventilation

The ventilation in the sauna room needs to be considered carefully. Proper air-flow allows bathers to enjoy fresh, oxygen-rich air. The air should fully change 6 times an hour. The supply air inlet should be installed on the wall or the ceiling at about 500 mm above the heater. The supply air inlet vent should be 50-100 mm in diameter. The outlet vent should be located as far away from the heater as possible, close to the floor. The outlet vent should be twice the size of the inlet vent.

### NOTE!

The thermostat sensor should be installed minimum of 1000 mm distance from an undirected supply air vent or at least 500 mm away from a vent directing air towards the sensor.

## Illustration of ventilation

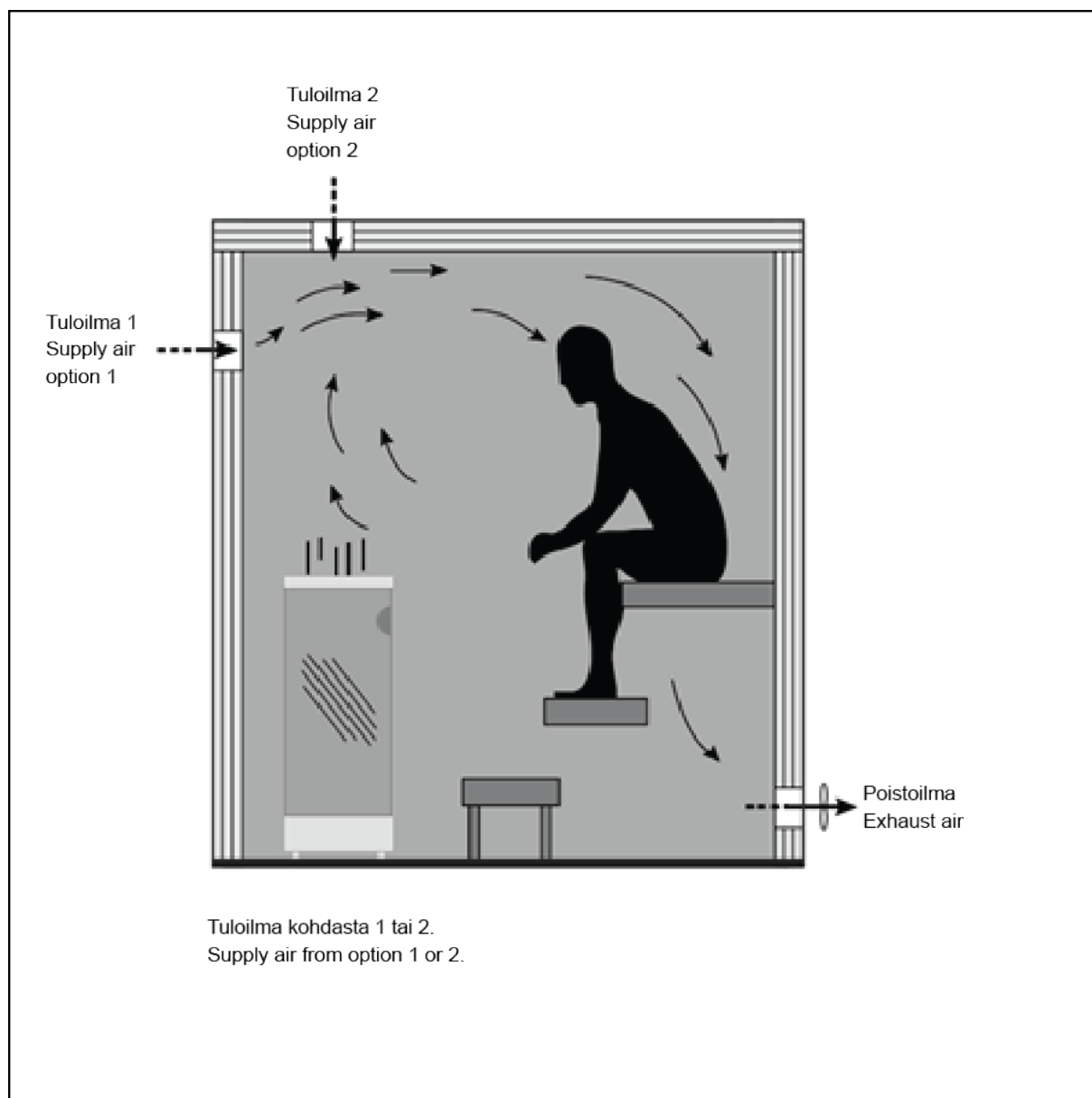

## Warnings

1. Staying in the hot sauna for long periods of time increases body temperature, which may be dangerous.
2. Keep away from the heater when it's hot. The stones and outer surface of the heater may cause burns when in contact with skin.
3. Prevent children from getting close to the heater.
4. Do not leave children, handicapped or ill people in the sauna without supervision.
5. Consult your doctor about any health concerns regarding sauna-bathing.
6. Consult child welfare clinic about taking babies to the sauna.
7. Always move carefully in the sauna, as the benches and floors may be slippery.
8. Never go to a hot sauna under the influence of alcohol, medication or narcotics.
9. Never sleep in a hot sauna.
10. Sea-air and a humid climate may corrode the metal surfaces of the heater.
11. Do not hang clothes to dry in the sauna, as this may cause a risk of fire. Excessive moisture content may also cause damage to the electrical equipment.

# IKI

---

KIUKAISTA KIUKAIN

CE IPX4 ~~II~~

Copyright IKI Kiuas Plc | We reserve the right to make changes